



## OPERATING INSTRUCTIONS

# DUAL POWER AMPLIFIERS

**DA-250D CE301**

**DA-250D CE-GB**

**DA-250D CE-AU**

**DA-250DH CE301**

**DA-250DH CE-GB**

**DA-250DH CE-AU**



An all-pole mains switch with a contact separation of at least 3 mm in each pole shall be incorporated in the electrical installation of the building.

Thank you for purchasing TOA's Dual Power Amplifier.  
Please carefully follow the instructions in this manual to ensure long, trouble-free use of your equipment.

TOA Corporation

# TABLE OF CONTENTS

<b>1. SAFETY PRECAUTIONS</b> .....	3
<b>2. GENERAL DESCRIPTION</b> .....	4
<b>3. FEATURES</b> .....	4
<b>4. HANDLING PRECAUTIONS</b> .....	5
<b>5. INSTALLATION PRECAUTIONS</b> .....	5
<b>6. NOMENCLATURE AND FUNCTIONS</b>	
Front .....	6
Rear .....	7
<b>7. SETTINGS AND CONNECTIONS</b>	
7.1. Switch Settings and Speaker Connections	
7.1.1. When using the DA-250D .....	8
7.1.2. When using the DA-250DH .....	9
<b>8. REMOVABLE TERMINAL PLUG CONNECTION</b> .....	10
<b>9. PROTECTION OPERATION LIST</b> .....	11
<b>10. TAMPER-PROOF CAP ATTACHMENT</b> .....	11
<b>11. CLEANING THE FILTER</b> .....	12
<b>12. DIMENSIONAL DIAGRAM</b> .....	12
<b>13. BLOCK DIAGRAMS</b>	
13.1. DA-250D .....	13
13.2. DA-250DH .....	13
<b>14. SPECIFICATIONS</b>	
14.1. DA-250D CE301, DA-250D CE-GB, DA-250D CE-AU .....	14
14.2. DA-250DH CE301, DA-250DH CE-GB, DA-250DH CE-AU .....	15

# 1. SAFETY PRECAUTIONS

- Before installation or use, be sure to carefully read all the instructions in this section for correct and safe operation.
- Be sure to follow all the precautionary instructions in this section, which contain important warnings and/or cautions regarding safety.
- After reading, keep this manual handy for future reference.

## Safety Symbol and Message Conventions

Safety symbols and messages described below are used in this manual to prevent bodily injury and property damage which could result from mishandling. Before operating your product, read this manual first and understand the safety symbols and messages so you are thoroughly aware of the potential safety hazards.



**WARNING**

Indicates a potentially hazardous situation which, if mishandled, could result in death or serious personal injury.



**CAUTION**

Indicates a potentially hazardous situation which, if mishandled, could result in moderate or minor personal injury, and/or property damage.



**WARNING**

### When Installing the Unit

- Do not expose the unit to rain or an environment where it may be splashed by water or other liquids, as doing so may result in fire or electric shock.
- Use the unit only with the voltage specified on the unit. Using a voltage higher than that which is specified may result in fire or electric shock.
- Do not cut, kink, otherwise damage nor modify the power supply cord. In addition, avoid using the power cord in close proximity to heaters, and never place heavy objects -- including the unit itself -- on the power cord, as doing so may result in fire or electric shock.
- Be sure to replace the unit's terminal cover after connection completion. Because the voltage of up to 100 V is applied to the high impedance speaker terminals, never touch these terminals to avoid electric shock. (DA-250DH only)
- External wiring connected to the terminals marked with ⚡ requires installation by an instructed person. (DA-250DH only)
- The apparatus shall be connected to a mains socket outlet with a protective earthing connection.

### When the Unit is in Use

- Should the following irregularity be found during use, immediately turn off this unit's power switch, disconnect the power supply plug from the AC outlet and contact your nearest TOA dealer. Make no further attempt to operate the unit in this condition as this may cause fire or electric shock.
  - If you detect smoke or a strange smell coming from the unit.
  - If water or any metallic object gets into the unit

- If the unit falls, or the unit case breaks
- If the power supply cord is damaged (exposure of the core, disconnection, etc.)
- If it is malfunctioning (no tone sounds.)
- To prevent a fire or electric shock, never open nor remove the unit case as there are high voltage components inside the unit. Refer all servicing such as modification inside the unit to qualified service personnel.
- Do not place cups, bowls, or other containers of liquid or metallic objects on top of the unit. If they accidentally spill into the unit, this may cause a fire or electric shock.
- Do not insert nor drop metallic objects or flammable materials in the ventilation slots of the unit's cover, as this may result in fire or electric shock.
- Do not touch a plug during thunder and lightning, as this may result in electric shock.



**CAUTION**

### When Installing the Unit

- Never plug in nor remove the power supply plug with wet hands, as doing so may cause electric shock.
- When unplugging the power supply cord, be sure to grasp the power supply plug; never pull on the cord itself. Operating the unit with a damaged power supply cord may cause a fire or electric shock.
- When moving the unit, be sure to remove its power supply cord from the wall outlet. Moving the unit with the power cord connected to the outlet may cause damage to the power cord, resulting in fire or electric shock. When removing the power cord, be sure to hold its plug to pull.

- Avoid installing the unit in humid or dusty locations, in locations exposed to the direct sunlight, near the heaters, or in locations generating sooty smoke or steam as doing otherwise may result in fire or electric shock.
- To avoid electric shocks, be sure to first turn off this unit's power switch when connecting speakers.
- The unit is designed exclusively to be mounted in an equipment rack. Be sure to follow the instructions below when rack-mounting the unit. Failure to do so may cause a fire or personal injury.
  - Install the equipment rack on a stable, hard floor. Fix it with anchor bolts or take other arrangements to prevent it from falling down.
  - The supplied rack-mounting screws can be used for the TOA equipment rack only. Do not use them for other racks.
  - When installing the unit in a rack other than that of TOA, be sure to use the screws with a diameter of over 5 mm and length of over 12 mm to mount the unit.
  - When connecting the unit's power cord to an AC outlet, use the AC outlet with current capacity allowable to the unit.
- Do not operate the unit for an extended period of time with the sound distorting. Doing so may cause the connected speakers to heat, resulting in a fire.
- Contact your TOA dealer as to the cleaning. If dust is allowed to accumulate in the unit over a long period of time, a fire or damage to the unit may result.
- If dust accumulates on the power supply plug or in the wall AC outlet, a fire may result. Clean it periodically. In addition, insert the plug in the wall outlet securely.
- Turn off this unit's power switch, and unplug the power supply plug from the AC outlet for safety purposes when cleaning or leaving the unit unused for 10 days or more. Doing otherwise may cause a fire or electric shock.



The lighting flash with arrowhead symbol, within an equilateral triangle, is intended to alert the user to the presence of uninsulated "dangerous voltage" within the product's enclosure that may be of sufficient magnitude to constitute a risk of electric shock to persons.

#### When the Unit is in Use

- Make sure to set all input level controls to ∞ (infinity) position before power is switched on. Loud noise produced when power is switched on with any of those controls set to the position other than ∞ position can impair hearing.

## 2. GENERAL DESCRIPTION

TOA's DA-250D and DA-250DH Dual Power Amplifiers feature high power handling capabilities and durability. The DA-250D is configured with 250 W x 2 channels (4 Ω output) and 170 W x 2 channels (8 Ω output), and the DA-250DH features a 250 W x 2 channels (100 V line, 40 Ω output) configuration. Besides, the DA-250D's output is made available for bridge connection, allowing it to be used as a 500 W (8 Ω) monaural amplifier. Their wide range of applications include stores and permanent sound systems.

## 3. FEATURES

- 1U rack mounting size\*.
- Low power consumption and light weight.
- An input signal to Channel 1 can be routed to both channels 1 and 2, and the output level adjusted using the input level control for each channel.
- Electronically-balanced inputs.
- Input terminals employ removable terminal blocks and XLR type connectors to provide maximum connection ease.
- Equipped with the LED indicators that show the input/output status, etc.
- Built-in protection circuitry disconnects the power amplifier's output from the load when a short circuit, overload, or unusual temperature rise occurs.

\* 1U size = 44.5 mm (reference size)

## 4. HANDLING PRECAUTIONS

- Keep the input cable away from the output cable. If installed close to each other, oscillation could occur.
- To avoid unit failures, never connect outputs of two or more channels in parallel.
- Only connect speakers with an impedance equal to or greater than those specified. Connecting speakers with a smaller impedance than specified could cause damage to the unit.
- Periodically clean the filter located inside the ventilation panel on the unit's front panel. If the filter becomes clogged, heat will become trapped inside the enclosure.
- Install the unit in locations where the temperature is between  $-10$  and  $+40^{\circ}\text{C}$  and the moisture is less than 90%RH (no dew condensation must be formed).
- To clean, be sure to first turn off this unit's power switch, then wipe with a dry cloth. When the unit gets very dirty, use a cloth dampened in a neutral cleanser. Never use benzene, thinner, alcohol, or chemically-treated cleaning cloth because such volatile liquids could deform or discolor the unit.
- The fan is a consumable product. As a guideline, we recommend that it be replaced with a new one when its total operating time reaches approximately 20000 hours (when used in ambient temperatures of approximately  $25^{\circ}\text{C}$ ).

**Note:** The above figure is simply a guideline, and does not guarantee the fan's operating life. Since broadcasts from the digital power amplifier could be disabled if the fan malfunctions, the fan requires regular inspection and maintenance. For maintenance service, please contact the dealer from whom the digital amplifier was purchased.

## 5. INSTALLATION PRECAUTIONS



### CAUTION

The supplied rack-mounting screws can be used for the TOA equipment rack only. Do not use them for other racks.

When installing the unit in a rack other than that of TOA, be sure to use the screws with a diameter of over 5 mm and length of over 12 mm to mount the unit.

Failure to do so may cause personal injury.

- The supplied power supply cord is designed for exclusive use with this unit. Never use it with other equipment.
- When mounting the unit in an equipment rack, the inside of the rack must be sufficiently ventilated. To achieve sufficient ventilation, remove all panels on the rear of the rack.
- When mounting the unit in the rack, also mount a Perforated Panel larger than 1U in size\*:
  - (1) at the top and the bottom of the rack, and
  - (2) above and below every 5 units.

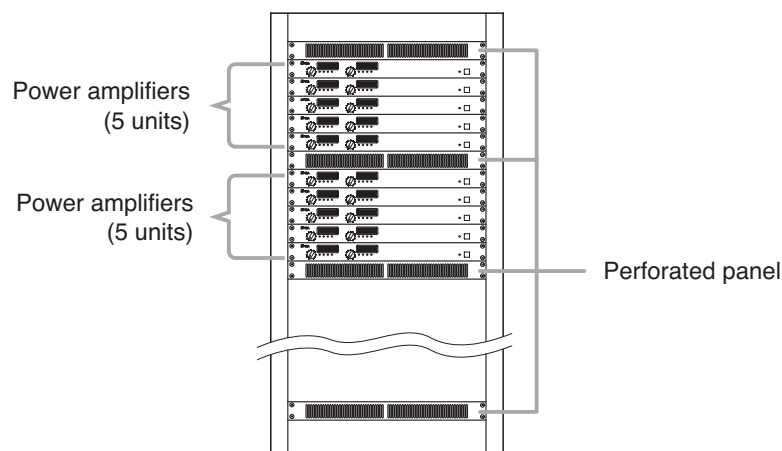

- Robust structure is one of the unit's main features. However, if the strength is particularly needed when installing the unit in the rack, use a supporting runner for the safety purposes.

\* 1U size = 44.5 mm (reference size)

## 6. NOMENCLATURE AND FUNCTIONS

[Front]

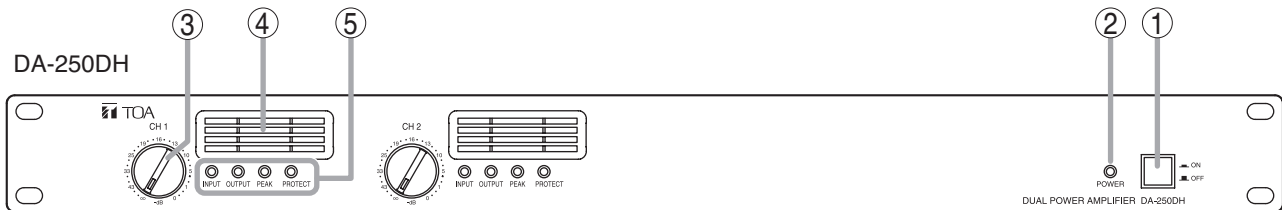
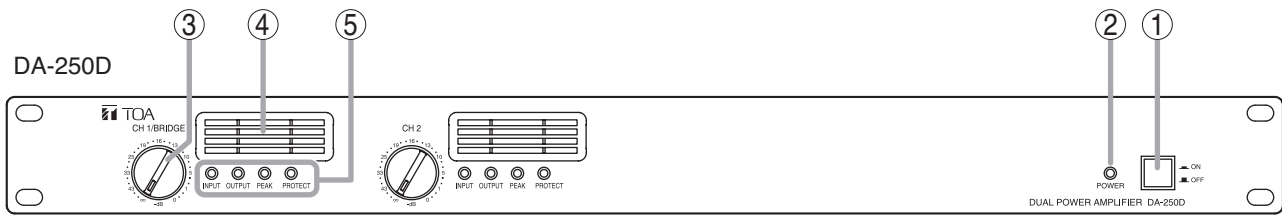

### 1. Power switch [ ON / OFF ]

Turning this switch on causes the amplifier to function, and turning it off causes the amplifier to cease function.

**Note:** The unit is not completely disconnected from the power supply even if this Power switch is turned off.

### 2. Power indicator [POWER]

Lights blue when the Power switch (1) is turned on.

### 3. Input level controls [CH 1 (BRIDGE), CH 2]

Adjust the input level of each channel.

Turn the control clockwise to increase the input level and counterclockwise to decrease the level.

#### When a bridge connection is made (DA-250D only)

When Channels 1 and 2 are bridge-connected (BRIDGE ON/OFF switch (9) is set to ON), the CH 1/BRIDGE level control adjusts the input levels of Channels 1 and 2.

In this event, the CH 2 level control cannot be used.

### 4. Ventilation panel (Air Vent)

A filter is located inside the ventilation panel. To clean the filter, remove the ventilation panel. (See p. 12; Cleaning the Filter.)

### 5. Indicators [INPUT, OUTPUT, PEAK, PROTECT]

The indicators are as follows from left to right:

#### • Input indicator [INPUT]

Lights green regardless of the input level control setting when an input signal level exceeds about  $-20$  dB.

#### • Output indicator [OUTPUT]

Lights yellow when an output level exceeds about 1 W at an  $8 \Omega$  load (DA-250D) or  $40 \Omega$  load (DA-250DH).

#### • Peak indicator [PEAK]

Lights red when an output signal clips (distortion occurs).

#### **Note**

When the Peak indicator lights, turn the input level control (3) counterclockwise until its light extinguishes or decrease the input signal level of the connected external device.

Operating the unit while the Peak indicator remains lit may cause the protection circuitry to be activated.

#### • Protection indicator [PROTECT]

Lights red when the protection circuitry is activated. (See p. 11; Protection Operation List.) When the power is switched on, this indicator lights for about 2 seconds and then extinguishes.

## [Rear]

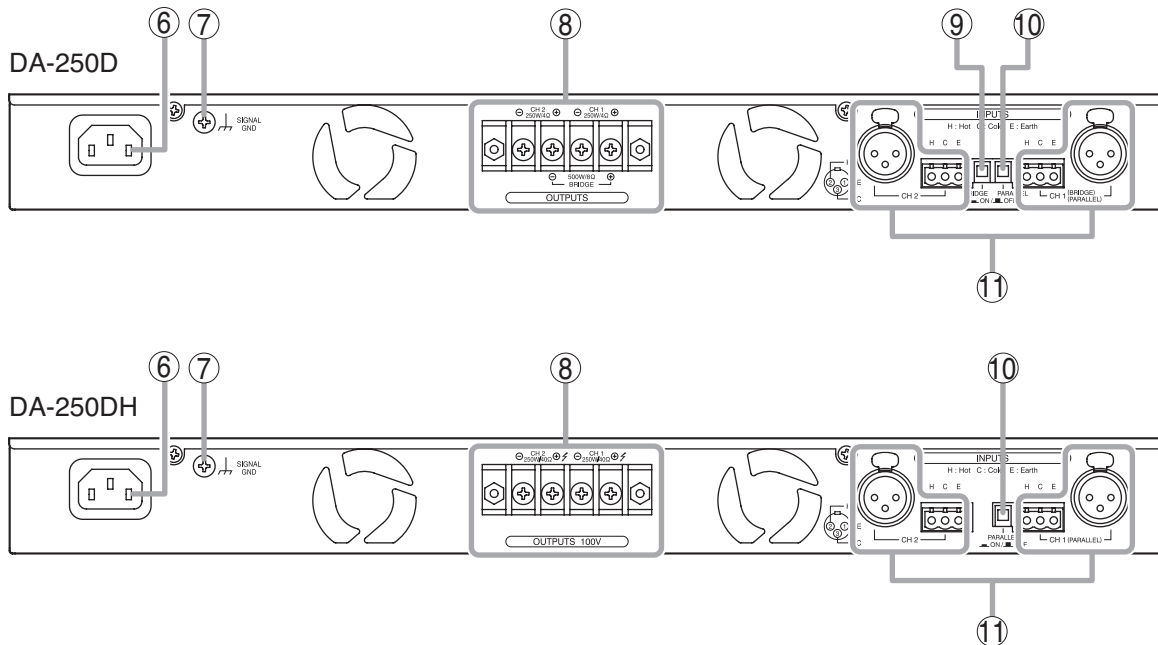

### 6. AC inlet

Connect the supplied power cord to this inlet. The socket-outlet shall be installed near the equipment and the plug (disconnecting device) shall be easily accessible.

### 7. Functional ground terminal [SIGNAL GND]

Hum noise may be generated when external equipment is connected to the unit. Connecting this terminal to the functional ground terminal of the external equipment may reduce the hum noise.

#### Note

This terminal is not for protective earth.

### 8. Speaker output terminals (with a terminal cover) [OUTPUTS (DA-250D), OUTPUTS 100V (DA-250DH)]

Connect speaker cables to these terminals.

### 9. BRIDGE ON/OFF switch (DA-250D only) [BRIDGE, ON / OFF]

Used when bridge-connecting the unit's Channels 1 and 2. (See p. 8; Settings and Connections.)

- **2-channel output mode**  
Set BRIDGE switch to OFF. (factory-preset)
- **1-channel output mode**  
Set BRIDGE switch to ON.

#### Note

Be sure to first turn off the Power switch (1) when changing these switch settings.

### 10. CH 1 mode ON/OFF switch

#### [PARALLEL, ON / OFF]

Setting this switch to ON transmits the Channel 1 input signal to both channels 1 and 2. (PARALLEL mode)

Note that output signal levels can be individually adjusted with each channel's Input level control (3).

Setting this switch to OFF (factory-preset) transmits each channel's input signal to each corresponding channel. (STEREO mode)

#### Note

Be sure to first turn off the Power switch (1) when changing this switch setting.

### 11. Input terminals [INPUTS]

Electronically-balanced input terminals. Each removable terminal block (3 pins) is internally connected in parallel to the corresponding XLR type connector.

- **Removable terminal block (3 pins)**  
H: Hot, C: Cold, E: Earth
- **XLR type male connector (XLR-3-31 equivalent)**  
Pin 1: Earth, Pin 2: Hot, Pin 3: Cold

#### Caution when using an XLR type plug

If a straight plug hits the rack's rear cover or wall behind the rack when it is used for connection, use the L-shaped plug instead.

# 7. SETTINGS AND CONNECTIONS

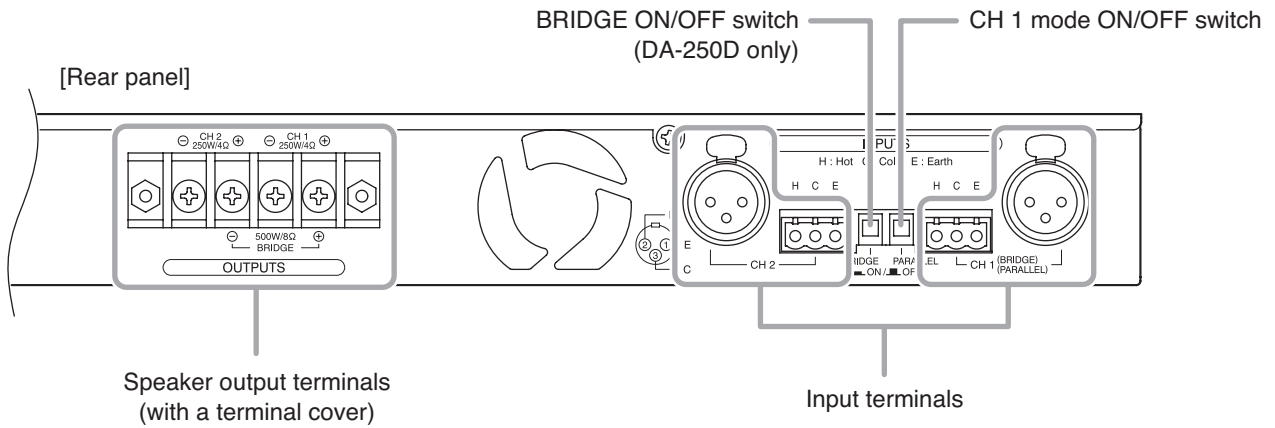

**Note:** The figure shows the DA-250D.

**Step 1.** Turn off this unit's Power switch.

**Step 2.** Set the BRIDGE ON/OFF switch (DA-250D only) and CH 1 mode ON/OFF switch.

**Step 3.** Connect the sound source equipment to the Input terminals.

**Note:** Refer to p. 10 for the removable terminal plug connection.

**Step 4.** Connect speakers to the Speaker output terminals.

4-1. Unscrew the output terminal cover.

4-2. Strip 10 mm of insulative jacket from the end of the speaker cable, as shown in the figure at right.

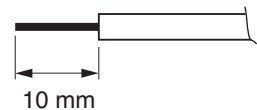

4-3. Connect speaker cables to the output terminals.

4-4. Replace the output terminal cover in place.

## ⚠ WARNING

Be sure to replace the unit's terminal cover after connection completion. Because high voltage is generated at the speaker output terminals, never touch these terminals to avoid electric shock. (DA-250DH only)

### 7.1. Switch Settings and Speaker Connections

#### 7.1.1. When using the DA-250D

[2 inputs - 2 outputs] (factory-preset)

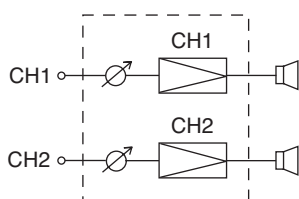

Switch	Setting
BRIDGE	OFF
CH 1 mode	OFF

Speaker output terminals

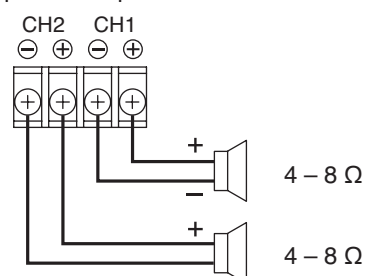



**[1 input - 2 outputs]**

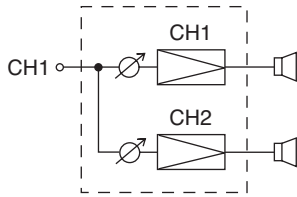

Switch	Setting
BRIDGE	OFF
CH 1 mode	ON

Speaker output terminals

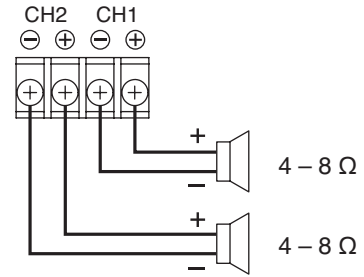

**[1 input - 1 output]**

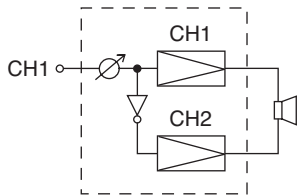

Switch	Setting
BRIDGE	ON

Speaker output terminals

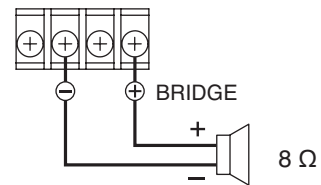

**Note**

Channel 1 input signal is output regardless of the CH1 mode ON/OFF switch setting.

**7.1.2. When using the DA-250DH**

**[2 inputs - 2 outputs] (factory-preset)**

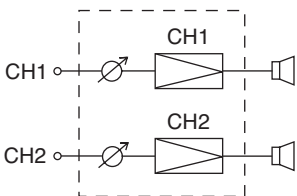

Switch	Setting
CH 1 mode	OFF

Speaker output terminals

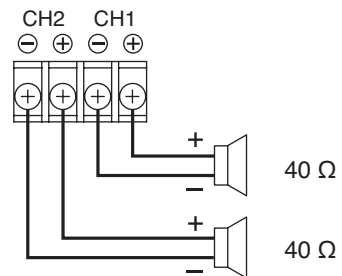

**[1 input - 2 outputs]**

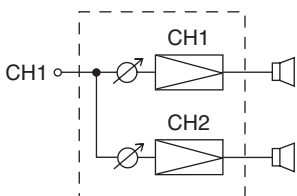

Switch	Setting
CH 1 mode	ON

Speaker output terminals

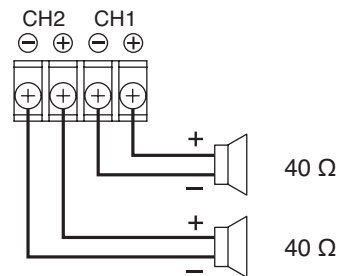

## 8. REMOVABLE TERMINAL PLUG CONNECTION

### Cautions

- Be sure to use shielded cables for audio signal lines.
- Avoid soldering cable conductor, as contact resistance may increase when the cable is tightened and the solder is crushed, possibly resulting in an excessive rise in joint temperatures.
- Use cables of AWG 12 – 24.

### Cable end treatment

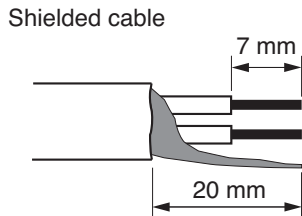

### Connector connections

**Step 1.** Loosen the terminal screw, then insert the cable.

**Step 2.** Retighten the terminal screw. (Pull on the cable to ensure it is securely connected.)

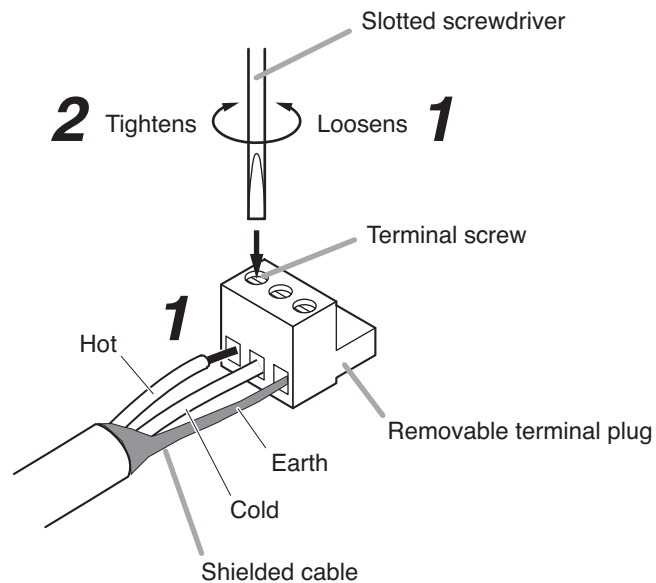

### Tip

Recommended slotted screwdriver type: Screwdriver with blade that is 3 mm in width

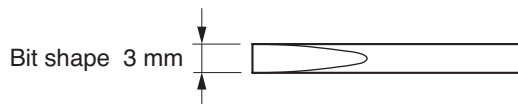

## 9. PROTECTION OPERATION LIST

Failure	Protection	Operation Indicator	Remedy	Recovery
Overcurrent due to overload	Current limiter activated when impedance drops below the specified value.	Peak indicator lights.	Remove overload.	Connecting a correct load automatically restores normal operation.
Short circuit	Current limiter activated. Load is disconnected.	Protection indicator lights.	Check speakers and lines for short circuit.	Turn off this unit's Power switch. Correct the load, then turn on the power.
Temperature rise at power amp. heat sink (over 100°C)	Load disconnected.	Protection indicator lights.	Check the unit for correct ventilation and overload.	Operation automatically returns to normal when the temperature decreases.
Temperature rise inside the unit (over 80°C)	Built-in amplifier unit that caused the failure halted.	Four indicators of the corresponding channel extinguish.		
Abnormal DC voltage output	Load disconnected.	Protection indicator lights.	Contact the TOA dealer where the unit was purchased.	

## 10. TAMPER-PROOF CAP ATTACHMENT

To protect the input level control from accidental operation, it is recommended to replace the control knob with the supplied tamper-proof cap as illustrated.

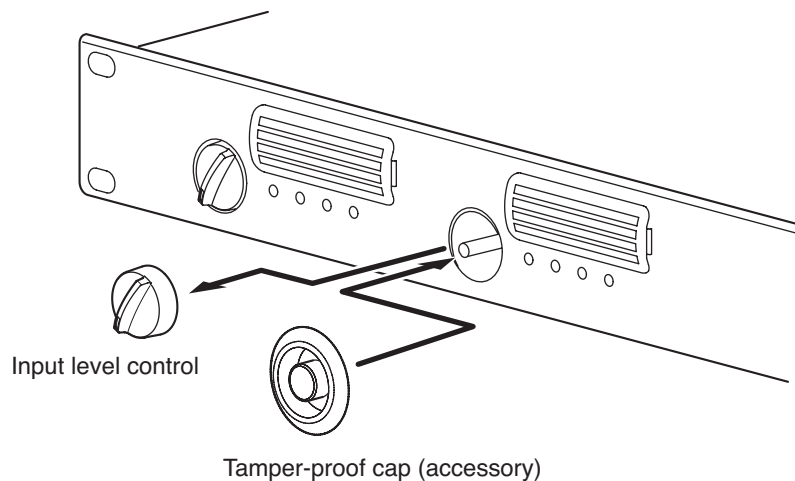

## 11. CLEANING THE FILTER

- Step 1.** Turn off this unit's Power switch.
- Step 2.** Remove the ventilation panel as shown in the figure.
- Step 3.** Detach the filter inside the ventilation panel.
- Step 4.** Clear the filter of dust.
- Step 5.** Replace the filter and ventilation panel.

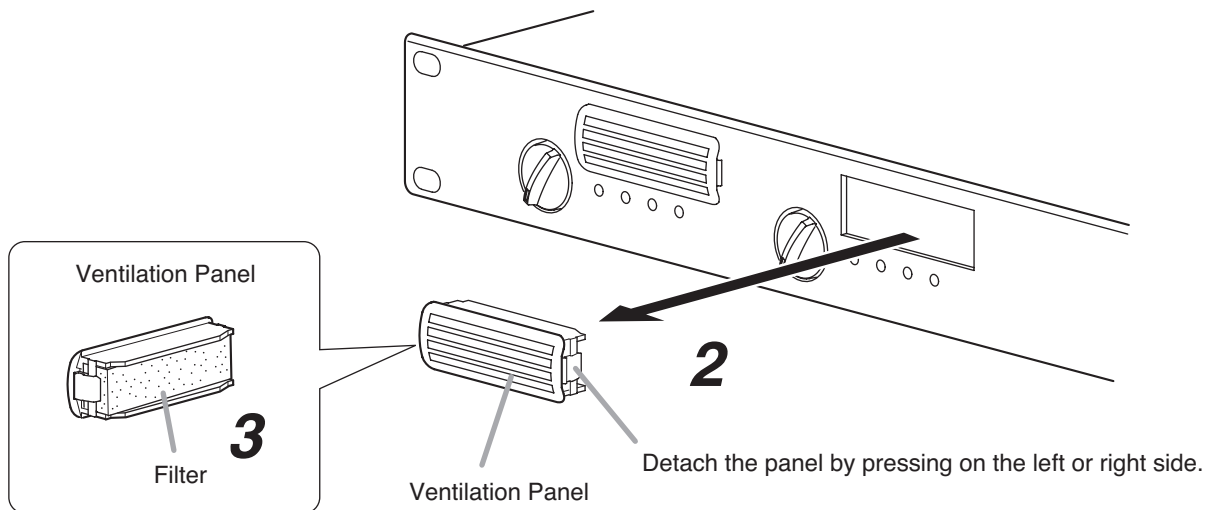

## 12. DIMENSIONAL DIAGRAM

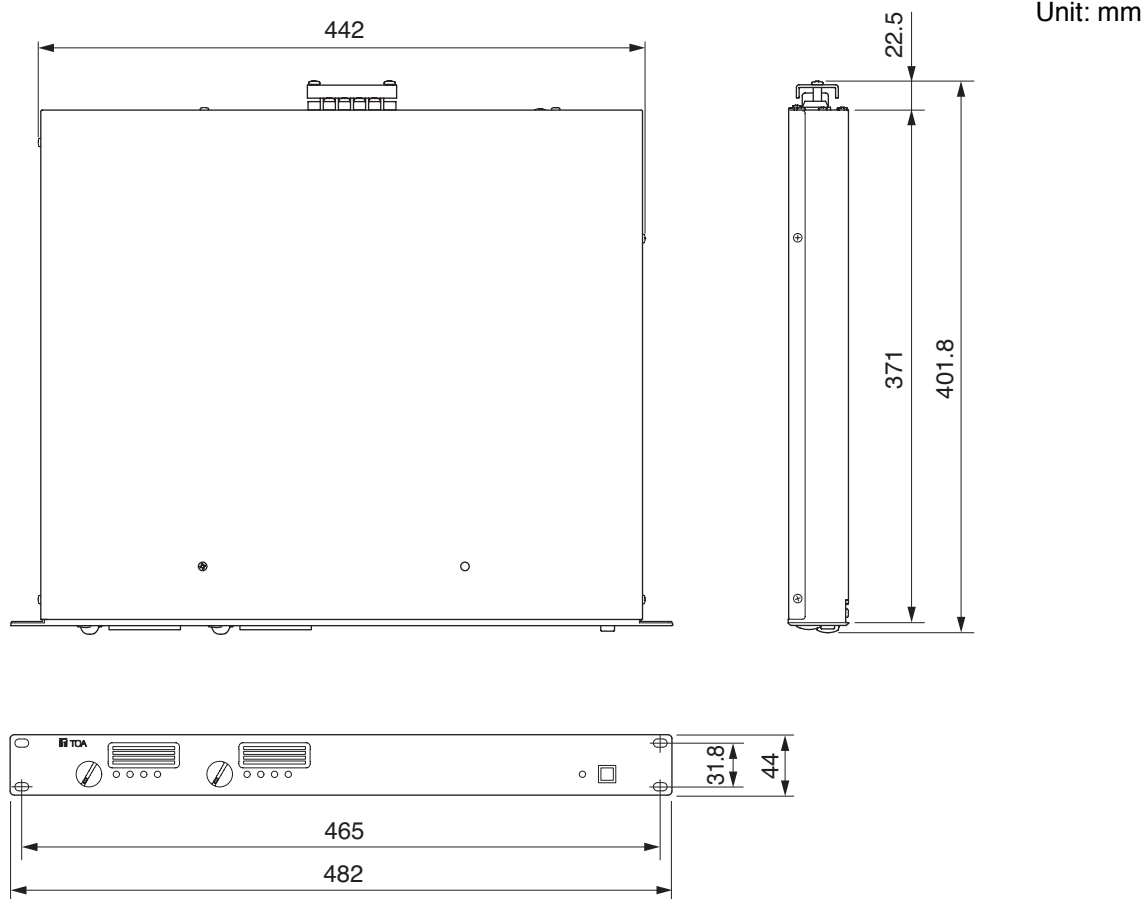

# 13. BLOCK DIAGRAMS

## 13.1. DA-250D

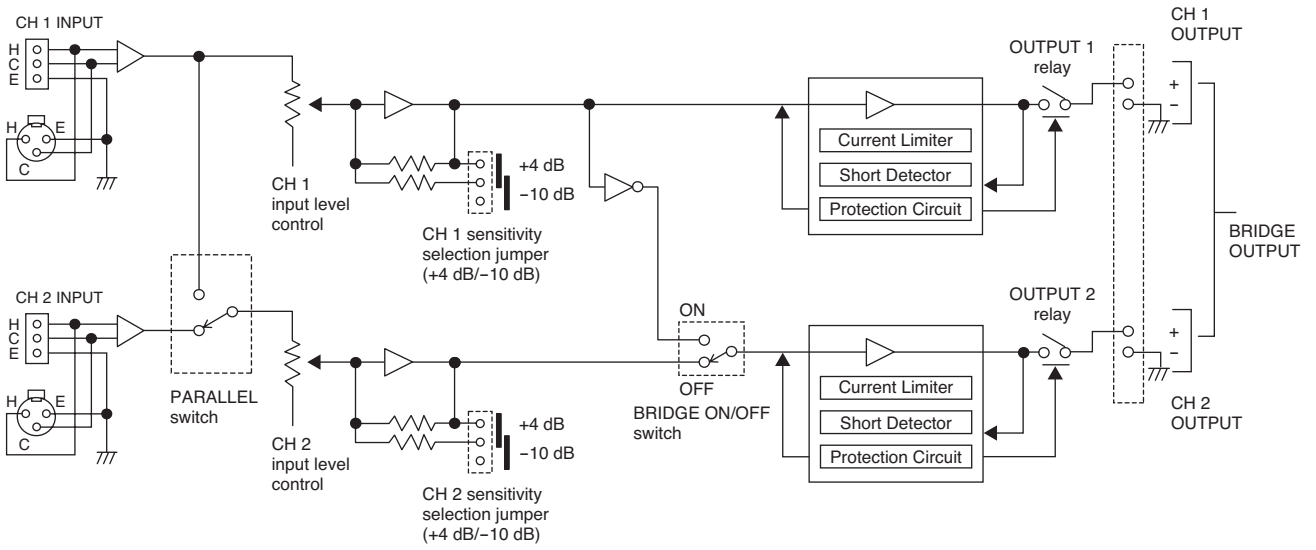

## 13.2. DA-250DH

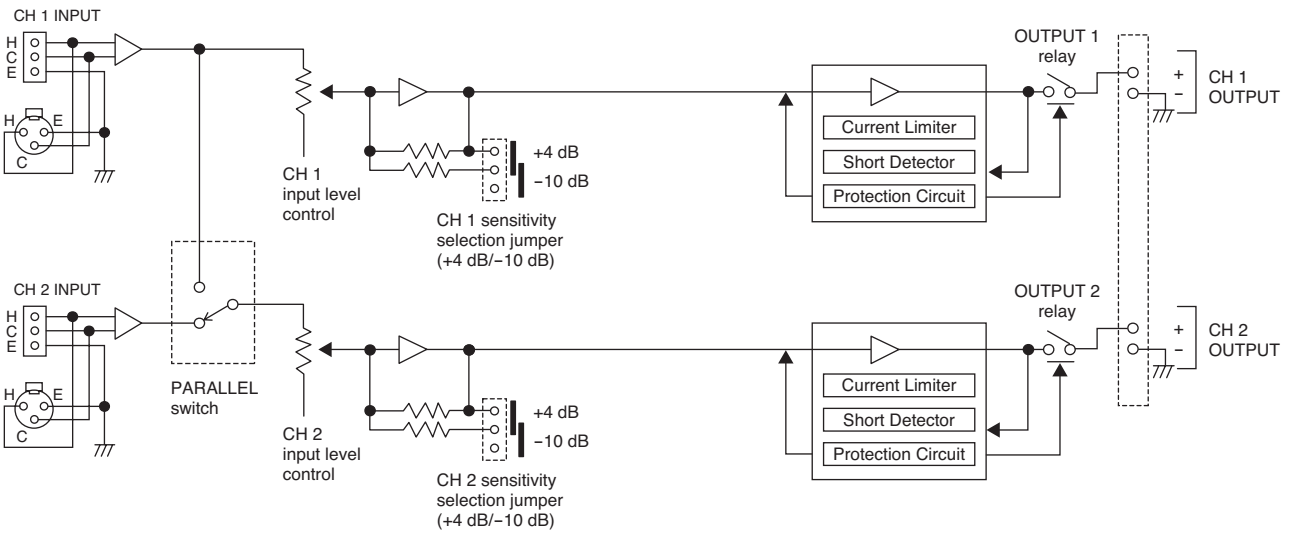

# 14. SPECIFICATIONS

## 14.1. DA-250D CE301, DA-250D CE-GB, DA-250D CE-AU

Power Source	220 – 240 V AC, 50/60 Hz
Amplification system	Class D
Power Consumption	120 W (based on EN standards) 620 W (rated output 4 Ω x 2) 400 W (rated output 8 Ω x 2)
Input	2 circuits, +4 dB* (1.23 V, input level control in maximum position), 10 kΩ, electronically-balanced, removable terminal block (3 pins), XLR-3-31 type connector CH 1 mode ON/OFF switch (ON: PARALLEL, OFF: STEREO)
Rated Output	2 channels: 250 W x 2 (4 Ω), 170 W x 2 (8 Ω) 1 channel (BRIDGE): 500 W (8 Ω) M4 screw terminal, distance between barriers: 8.8 mm
Frequency Response	20 – 20,000 Hz (±1 dB)
Total Harmonic Distortion	0.1% (1 kHz), 0.3% (20 – 20,000 Hz)
Protection Circuit	Protection against excessive current flow due to overload, short circuit, unusual DC voltage output, temperature rise at power amp. heat sink (over 100°C), temperature rise inside the unit (over 80°C)
S/N Ratio	100 dB (A-weighted)
Crosstalk	70 dB (A-weighted)
LED Indicator	Power (blue) x 1, Input (green) x 2, Output (yellow) x 2, Peak (red) x 2, Protect (red) x 2
Cooling	Forced air cooling
Operating Temperature	-10°C to +40°C
Operating Humidity	Under 90%RH (no condensation)
Finish	Panel: Aluminum, black, alumite Case: Plated steel sheet
Dimensions	482 (w) x 44 (h) x 401.8 (d) mm
Weight	5.3 kg

\* 0 dB = 0.775 V

**Note:** The design and specifications are subject to change without notice for improvement.

**• Accessories**

Power cord (2 m) .....	1
Removable terminal plug (3 pins) .....	2
Rack mounting screw (with plain washer) 5 x 12 .....	4
Tamper-proof cap .....	2

## 14.2. DA-250DH CE301, DA-250DH CE-GB, DA-250DH CE-AU

Power Source	220 – 240 V AC, 50/60 Hz
Amplification system	Class D
Power Consumption	120 W (based on EN standards) 580 W (rated output 100 V line, 40 Ω x 2)
Input	2 circuits, +4 dB* (1.23 V, input level control in maximum position), 10 kΩ, electronically-balanced, removable terminal block (3 pins), XLR-3-31 type connector CH 1 mode ON/OFF switch (ON: PARALLEL, OFF: STEREO)
Rated Output	2 channels: 250 W x 2 (100 V line, 40 Ω) M4 screw terminal, distance between barriers: 8.8 mm
Frequency Response	50 – 20,000 Hz (–3 dB, +1 dB)
Total Harmonic Distortion	0.1% (1 kHz), 0.3% (100 – 20,000 Hz)
Protection Circuit	Protection against excessive current flow due to overload, short circuit, unusual DC voltage output, temperature rise at power amp. heat sink (over 100°C), temperature rise inside the unit (over 80°C)
S/N Ratio	100 dB (A-weighted)
Crosstalk	70 dB (A-weighted)
LED Indicator	Power (blue) x 1, Input (green) x 2, Output (yellow) x 2, Peak (red) x 2, Protect (red) x 2
Cooling	Forced air cooling
Operating Temperature	–10°C to +40°C
Operating Humidity	Under 90%RH (no condensation)
Finish	Panel: Aluminum, black, alumite Case: Plated steel sheet
Dimensions	482 (w) x 44 (h) x 401.8 (d) mm
Weight	5.3 kg

\* 0 dB = 0.775 V

**Note:** The design and specifications are subject to change without notice for improvement.

### • Accessories

Power cord (2 m) .....	1
Removable terminal plug (3 pins) .....	2
Rack mounting screw (with plain washer) 5 x 12 .....	4
Tamper-proof cap .....	2

**Traceability Information for Europe (EMC directive 2004/108/EC)**

Manufacturer:  
TOA Corporation  
7-2-1, Minatojima Nakamachi, Chuo-ku, Kobe, Hyogo,  
Japan

Authorized representative:  
TOA Electronics Europe GmbH  
Suederstrasse 282, 20537 Hamburg,  
Germany